



Retroreflective sensor

RL29-55-V/73c/136



- Foreground suppression, suited to recording of sheet-shrink-wrapped objects
- Highly visible LED
- Powerful push-pull output
- Optimal price/power ratio

Retroreflective sensor with polarization filter



Dimensions

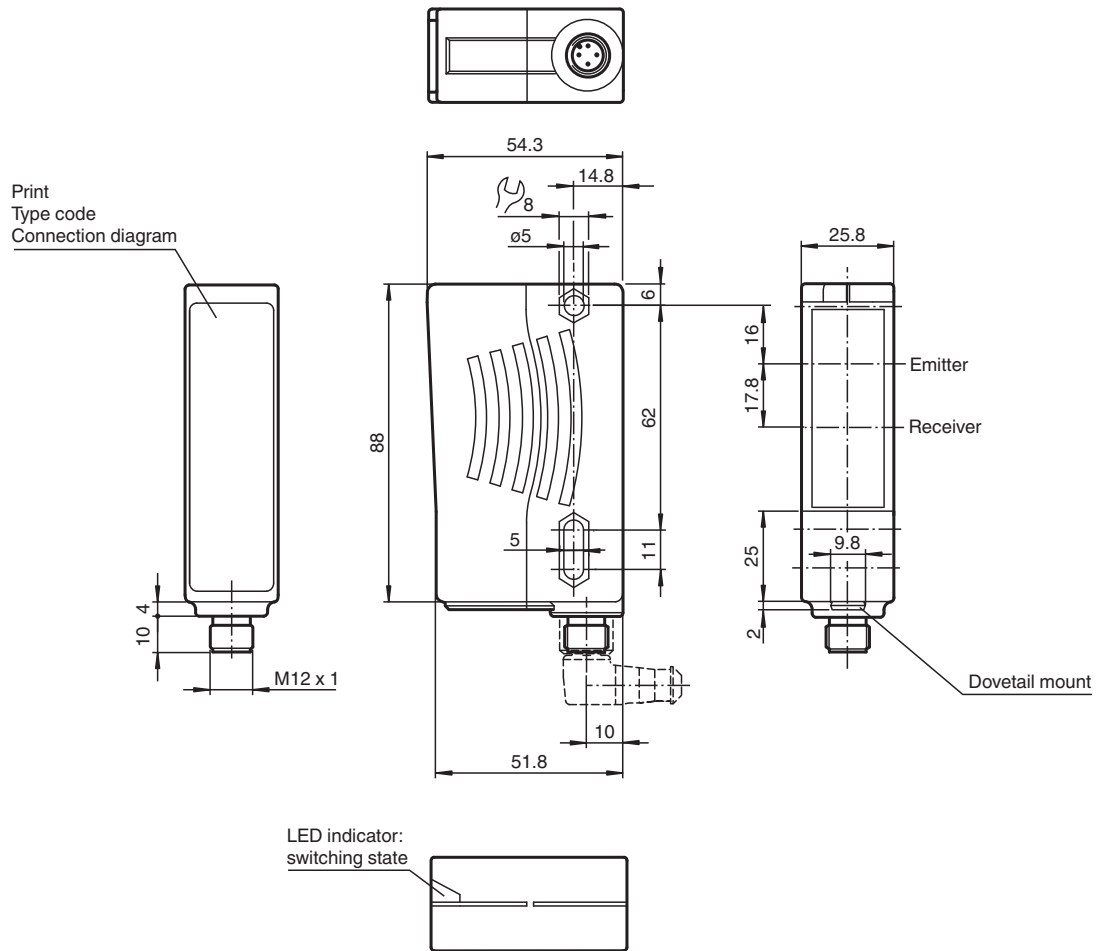

Technical Data

General specifications

Effective detection range	0.4 ... 6 m
Threshold detection range	8 m
Reference target	H85 reflector
Light source	LED, 660 nm
Light type	modulated visible red light
Polarization filter	yes
Diameter of the light spot	approx. 130 mm at a distance of 6 m
Angle of divergence	Emitter: 1.2 ° , Receiver: 2 °
Ambient light limit	80000 Lux

Functional safety related parameters

MTTF _d	1982.2 a
Mission Time (T _M)	20 a
Diagnostic Coverage (DC)	0 %

Indicators/operating means

Function indicator	LED yellow, light with free light beam , flashes when falling short of the stability control
--------------------	--

Electrical specifications

Operating voltage	U _B	10 ... 30 V DC , class 2
Ripple		10 %
No-load supply current	I ₀	≤ 30 mA

Output

Switching type	dark on
----------------	---------

Technical Data

Signal output		2 push-pull (4 in 1) outputs, short-circuit protected, reverse polarity protected
Switching voltage		max. 30 V DC
Switching current		max. 100 mA
Switching frequency	f	500 Hz
Response time		1 ms
Conformity		
Product standard		EN 60947-5-2
Approvals and certificates		
UL approval		cULus Listed, Class 2 Power Source, Type 1 enclosure
CCC approval		CCC approval / marking not required for products rated ≤ 36 V
Approvals		CE, cULus Listed 57M3 (Only in association with UL Class 2 power supply; Type 1 enclosure)
Ambient conditions		
Ambient temperature		-25 ... 60 °C (-13 ... 140 °F)
Storage temperature		-40 ... 75 °C (-40 ... 167 °F)
Mechanical specifications		
Housing width		25.8 mm
Housing height		88 mm
Housing depth		54.3 mm
Degree of protection		IP65
Connection		Plastic connector M12 x 1, 4-pin
Material		
Housing		Plastic ABS
Optical face		plastic
Mass		70 g

Connection Assignment

Option:

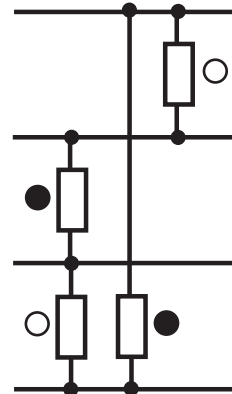
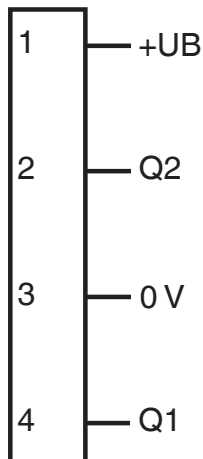

○ = Light on
● = Dark on

Connection Assignment

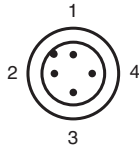

Wire colors in accordance with EN 60947-5-2

1	BN	(brown)
2	WH	(white)
3	BU	(blue)
4	BK	(black)

Characteristic Curve

Characteristic response curve

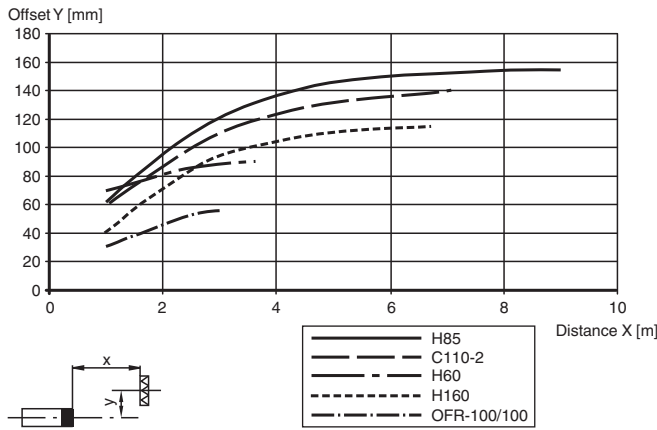





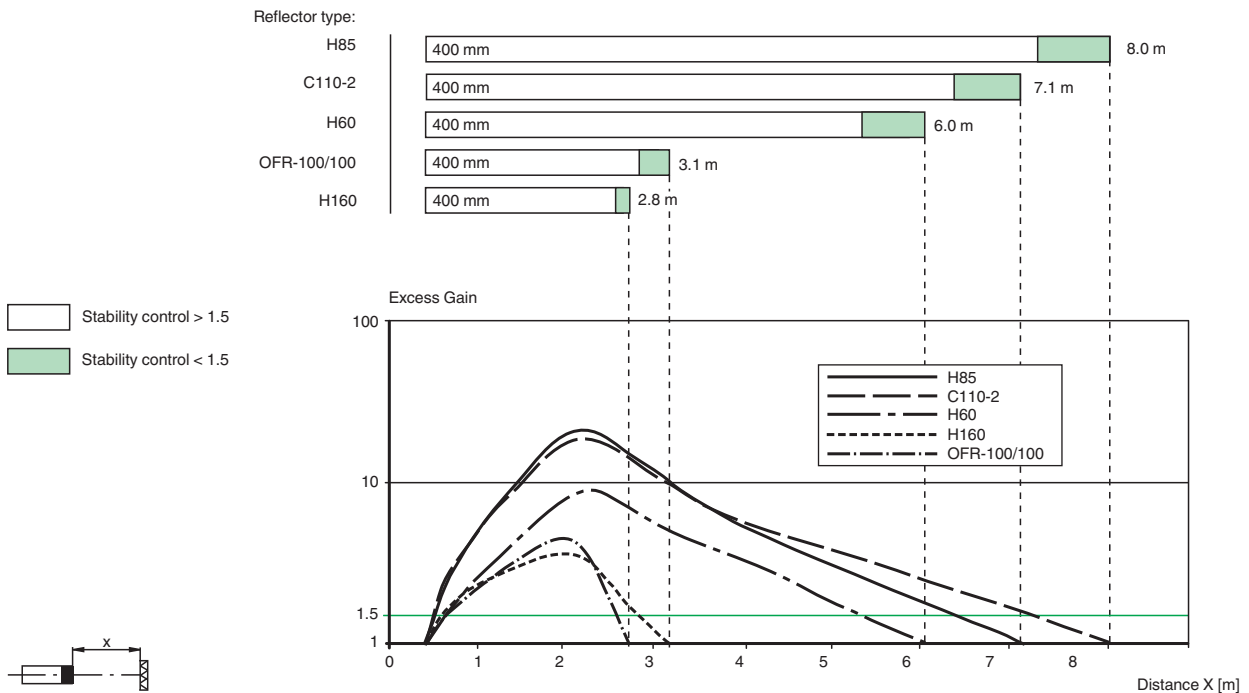

Excess Gain vs. Sensing Range

RL29-55-V



Release date: 2020-10-08 Date of issue: 2020-10-08 Filename: 801764_eng.pdf

Accessories

	OMH-05	Mounting aid for round steel ø 12 mm or sheet 1.5 mm ... 3 mm
	OMH-21	Mounting bracket
	OMH-22	Mounting bracket
	OMH-RLK29-HW	Mounting bracket for rear wall mounting
	OMH-RL28-C	Weld slag cover model
	V1-G-2M-PUR	Female cordset, M12, 4-pin, PUR cable
	V1-W-2M-PUR	Female cordset, M12, 4-pin, PUR cable

Components

Suitable reflectors and cable sockets can be found in the Internet

Release date: 2020-10-08 Date of issue: 2020-10-08 Filename: 801764_eng.pdf

Refer to "General Notes Relating to Pepperl+Fuchs Product Information".

Pepperl+Fuchs Group
www.pepperl-fuchs.com

USA: +1 330 486 0001
fa-info@us.pepperl-fuchs.com

Germany: +49 621 776 1111
fa-info@de.pepperl-fuchs.com

Singapore: +65 6779 9091
fa-info@sg.pepperl-fuchs.com

 **PEPPERL+FUCHS**